



UD TRUCKS

NEW
Quester

Made to go the extra mile



Going the Extra Mile



INTRODUCTION

The Journey to New Quester.

An evolution in Japanese innovation.

Every great story starts with a dream. In UD Trucks' case, the dream started for our founder Kenzo Adachi in 1935 when he had the vision to create the trucks the world needs today. With this inspiration, he took the legendary 3,000km test drive across Japan, an

astonishing adventure that already then demonstrated the exceptional durability of the company's trucks.

Since then, UD Trucks has earned a global reputation of delivering durable, reliable and efficient trucks, with

Ultimate Dependability. Our official export business began in 1961, and since then the philosophy of always going the extra mile for our global customers has helped us supply innovation and reliability to several generations of fleet owners and drivers.

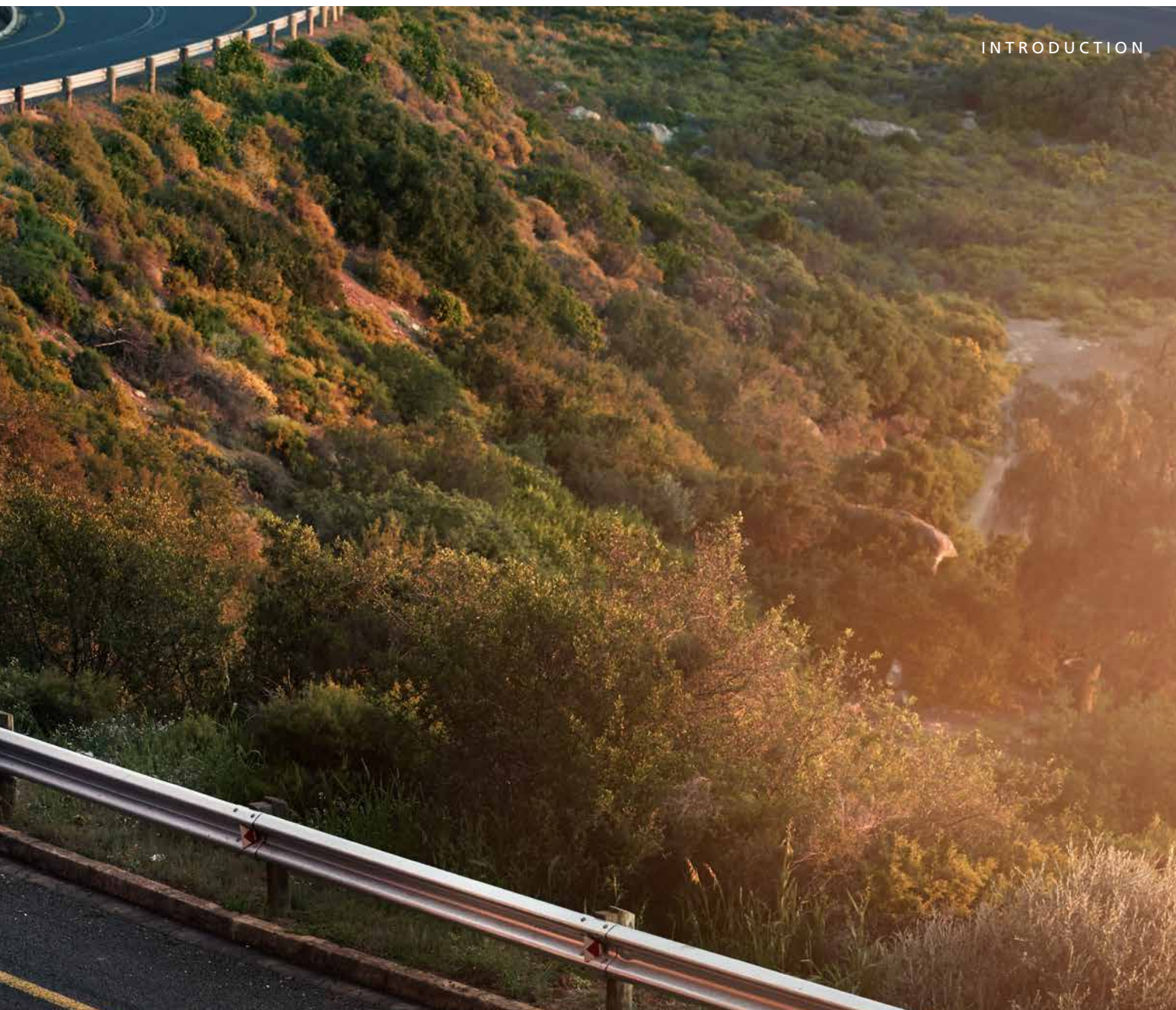

Quester – a proven transport solution.

Quester is a heavy-duty truck that combines first-class fuel efficiency with durability. On its launch, the Quester provided solutions to the transport industry that required flexibility and efficiency.

Part of a new generation of UD trucks, Quester was specifically developed for all types of heavy-duty transport assignments, and developed with the global resources of the Volvo Group. A major milestone.

And now Quester has evolved with the world.

New Quester is here – an evolution that provides smarter solutions to today's transport challenges. Building on proven robustness and reliability, New Quester introduces key features such as ESCOT automated manual transmission, retarder, electrical cab tilt, engines with higher horse power and user-friendly telematics. These deliver even greater productivity, fuel efficiency, uptime, driver efficiency and safety.

New Quester, a smart move for your business.







New design

Smart new decals are available as part of the truck's upgraded design.

A SMART MOVE FOR YOUR BUSINESS

New Quester features.

New Quester has a host of new features that let you focus on running your operations the way you need to.

-  **PRODUCTIVITY** 8–13
-  **FUEL EFFICIENCY** 14–19
-  **DRIVER EFFICIENCY** 20–23
-  **SAFETY** 24–27
-  **UPTIME** 28–33

ESCOT

The latest in automated manual transmission is an exciting development for easier, fuel efficient driving. *Page 14.*

ECO-Roll (with ESCOT)

Find out how this enhances fuel economy. *Page 17.*

E-viscous fan

For enhanced engine fuel economy. *Page 19.*

New power options

UD Trucks' GH8E and GH11E engines feature new power alternatives for New Quester. *Page 19.*

*440hp on the GH11E and the 350hp on the GH8E are now available.

Transmission Retarder

Slows the truck on downhills, reducing brake wear and risk of accidents. *Page 13.*





Geofencing via UD Telematics

Optimize your fleet by setting the best routes for optimal uptime and driver efficiency. *Page 32.*

New driver seat

Comfortable, new air suspension seat for added driver comfort. *Page 23.*

Electrical cab tilt

Allows easier tilting of cab for faster and safer maintenance. *Page 31.*

Additional axle ratios

Increase your performance and payload possibilities. *Page 13.*

Aluminium fuel tanks & wheel rims

New Quester is lighter, partly thanks to this combo. *Page 10.*

Cab air suspension

Versatile cab air suspension offers more comfort for drivers. *Page 23.*



New Quester models for new possibilities
*From distribution to long haul,
New Quester has your business needs covered.*

- CKE: 4x2 Rigid
- CDE: 6x2 Rigid
- CWE: 6x4 Rigid
- CQE: 8x2 Rigid
- CGE: 8x4 Rigid
- GKE: 4x2 Tractor
- GDE: 6x2 Tractor
- CWE: 6x4 Tractor

For more information, please refer to our separate segment brochures.



A smart move for new possibilities **MEET THE NEW QUESTER RANGE.**

New Quester's flexibility makes it suitable across a variety of applications and segments such as general cargo, long haul, construction and waste management. And now ESCOT's added power and performance in New Quester means that these and many other assignments can be carried out with increased fuel and driver efficiency. Optimized specifications such as reduced tare weight allow you to carry more. And with the introduction of smart new connected features such as telematics, you can stay on top of your tough daily schedule.

The Challenge **NEED FOR GREATER PAYLOAD.**

Maximizing your resources equates to ensuring productivity and efficiency on every transport assignment. Every truck in your fleet should operate at its capacity.

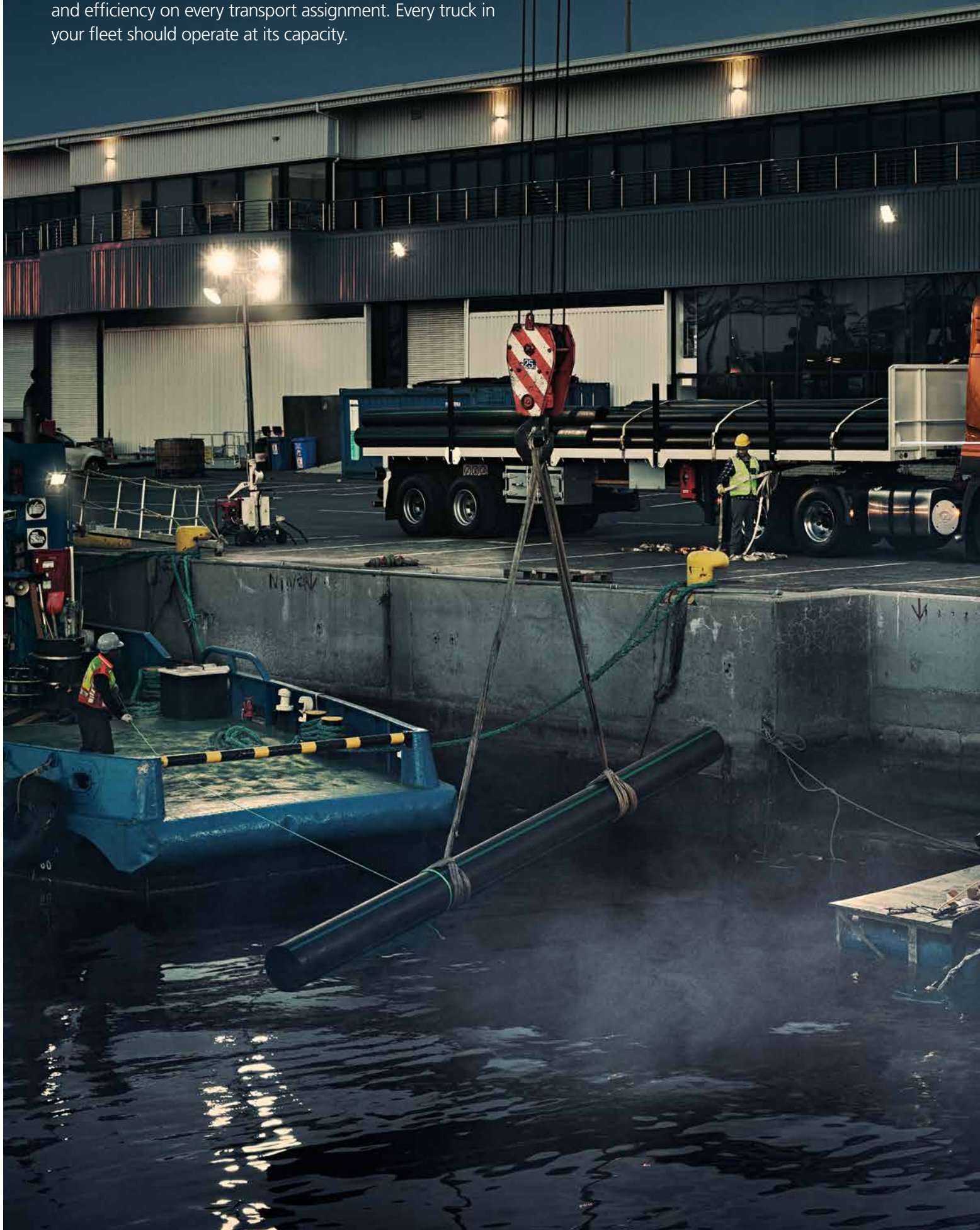

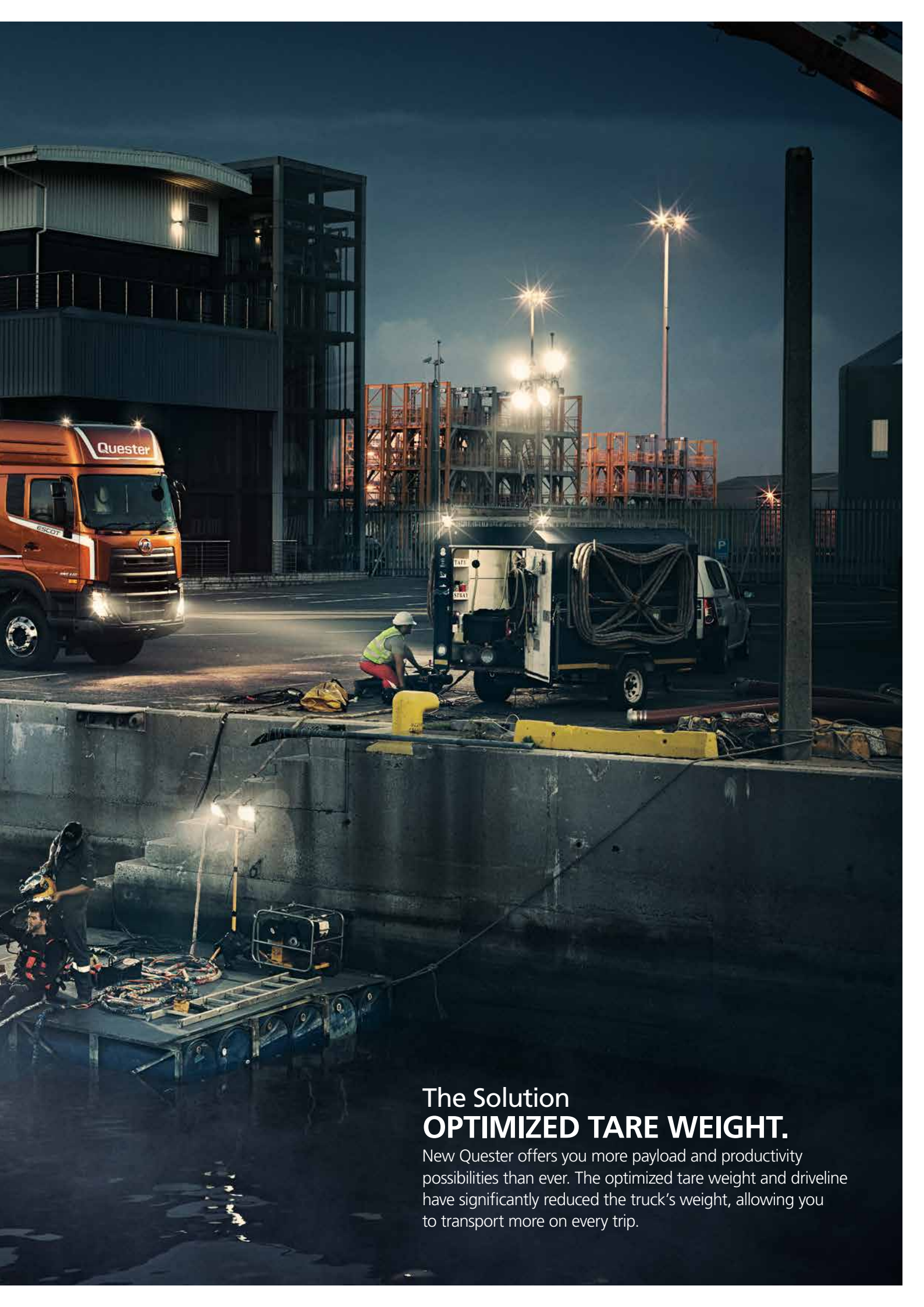

The Solution **OPTIMIZED TARE WEIGHT.**

New Quester offers you more payload and productivity possibilities than ever. The optimized tare weight and driveline have significantly reduced the truck's weight, allowing you to transport more on every trip.



A SMART MOVE FOR **PRODUCTIVITY**

Transport more with New Quester.

When combined with a powerful driveline, lighter tare weight offers the possibility to transport more cargo on longer distances.

- Strong, durable and lighter aluminium wheels and tanks mean more cargo can be carried
- Larger aluminum fuel tanks capacity allows your trucks to be on the road longer



New Quester's high performance driveline teams up with lighter tare weight to make long haul, distribution, construction, waste or utility assignments more productive.



Optimized driveline

The 8-liter and 11-liter engines powered by UD Trucks' advanced technology, combine reliability with top class performance. Delivering high torque from low revs with flat torque curves, these modern engines provide:

- Better pulling power and easier driving.
- Improved fuel efficiency.
- Extended maintenance intervals.
- Longer life of the engine.

And with a wider range of power specifications now available, the new truck offers even greater flexibility for more assignments. By selecting the right powertrain combination, you increase driver efficiency, helping boost your bottom line.

ESCOT – automated manual transmission

With key components made of aluminium, ESCOT* automated manual transmission contributes to New Quester's low weight for higher payload. Choosing the right gear at

all times, ESCOT delivers efficient, productive driving with high average speeds and low operating costs.

The PWR+ mode on ESCOT makes construction assignments productive with increased power and high running performance in tough conditions. It features a rock loose mode for quick escape when stuck in slippery and muddy conditions.

Optimized for both on-road and off-road applications. It is factory installed and available on New Quester models.

Robust manual transmissions

All New Quester models also come with a choice of reliable and durable, 6-speed, 9-speed and 12-speed manual transmission, that are able to cope with the toughest demands in various operation conditions.

Allison – automatic transmission

Whether servicing city distribution, waste management or out on the construction site, New Quester featuring Allison is a perfect solution for start-stop operations, with its torque converter. Drivers at all levels experience less fatigue, and can focus on the road at all times and during any maneuver. No clutch also means lower maintenance costs.

Available on New Quester:

Allison 3000/ 3200 for GH8E
Allison 4000 for GH11E

*Read more about how ESCOT works on page 14.

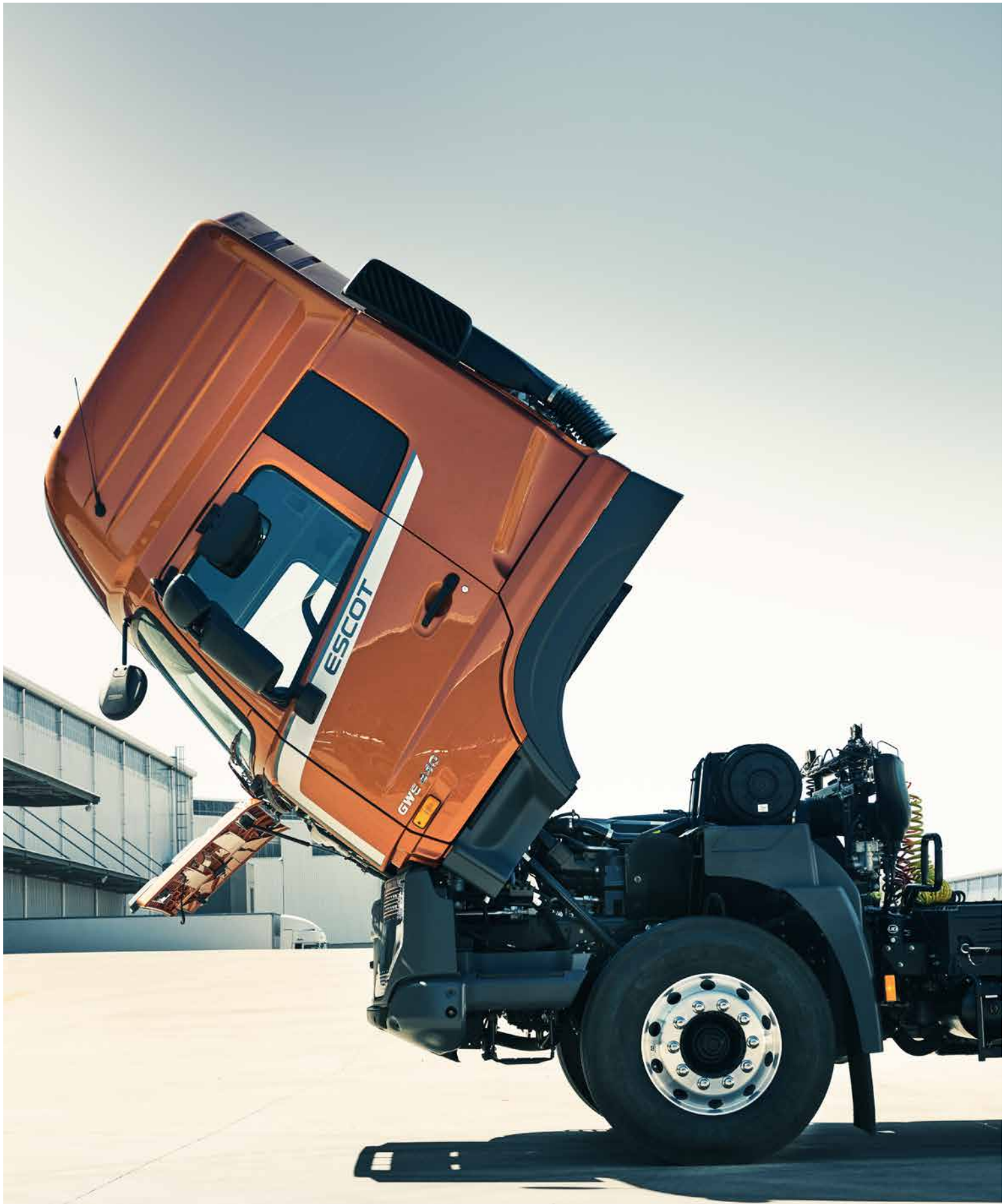

**Easy superstructure
INSTALLATION**

New Quester is designed for ease of superstructure installation, with comprehensive bodybuilder instructions and drawings. The parallel side members, designed for bodybuilder mounts and range of power take-offs make installation easier.

Open up for greater productivity.

With a variety of innovative features, New Quester offers new possibilities for better business.



Seamless fleet control.

UD Telematics is a high-tech wireless communications system that helps your fleet towards greater productivity. It integrates a host of features designed to support you and your business. The new easy-to-use UD Telematics mobile app makes 24/7 fleet management convenient and simple.

Read more about telematics on page 33.



Flexible cab layout

The largest cab in UD Trucks' history is perfect for long haul. Walk-through with bunk beds and plenty of storage, the largest in class high roof cab also features a clear instrument panel where everything is within easy reach. More productive assignments are the result.



More ratios with new axle

Additional ratios on the new single reduction axles allow better flexibility in optimizing the driveline for your application.

- Robust high-strength material delivers superior performance
- Greater choice to suit need for torque, traction or fuel economy



Class-leading axle loads

Quester tops the class in terms of front and rear axle loads.

- Both axles are built extra durable to enable high loads
- Hub reduction version is available for tough construction assignments



Transmission retarder

A new hydraulic retarder delivers enhanced braking torque. This helps New Quester improve productivity by making journeys faster. The retarder is coordinated with UD Trucks' Extra Engine Brake and maintains a steady speed while travelling downhill without using service brakes.

The retarder delivers several key benefits including:

- Reduced brake wear
- Steady speed of travel on long downhill drives
- Reduced probability of accidents due to brake fade



The Solution **GH11E ENGINE WITH ESCOT.**

Building on Quester's excellent fuel economy, New Quester introduces ESCOT automated manual transmission (AMT). Automated gear shifting makes New Quester easier to drive and more fuel efficient, even for new drivers. Helping you make the break towards lower operating costs.

The Challenge **RISING FUEL COSTS.**

Rising fuel costs have become a major issue for the transport industry globally. Increasing overheads are putting pressure on your business. It's tough to stay ahead of the competition.





A SMART MOVE FOR FUEL EFFICIENCY

ESCOT – big news for New Quester.

Easy & Safe Controlled Transmission. First created in 1995 in Japan to reduce fatigue by eliminating clutch operation, ESCOT continues to evolve. Now matched with New Quester, it enables all drivers to achieve superior fuel efficiency.

So what is ESCOT?

- A fast-responding automated manual transmission that has built-in intelligence
- Quickly and automatically choosing the right gear at all times



ESCOT: The Benefits

- Better fuel efficiency via seamless gear shifting for every driver
- Improved productivity and efficiency via easier driving
- Less stress and fatigue increases safety
- PWR+ mode offers greater driving stability and smoother takeoff in tough conditions

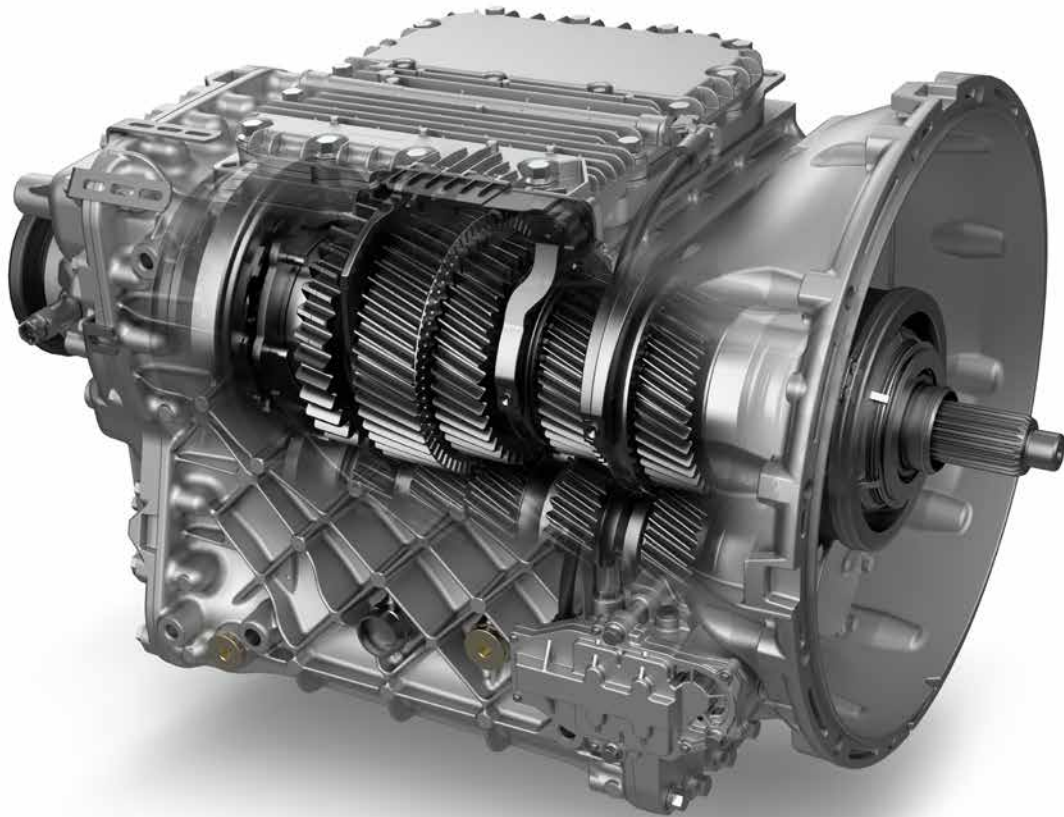

How does it work?

- ESCOT-E automated manual transmission features a non-synchromesh manual gearbox that has an electronically regulated pneumatic gear changing system and an automatic clutch.
- The secret of seamless gear changes lies in the intelligent electronic control unit, controlling the pneumatic system that handles the clutch and shifts.
- By constantly receiving information about speed, acceleration, weight, road condition, torque demand and more, ESCOT-E can carry out every shift with extreme precision.
- It also communicates closely with the engine to adjust revs and engine brake effect for fast, comfortable, fuel efficient gear shifts.

How does it actually improve fuel efficiency?

First of all, internal energy losses are low – actually lower than on manual gearboxes. However it's the electronics that really make the difference. When driving in ECO mode, every gear change is timed precisely, to let the engine work at its most efficient rpm range.

ECO-ROLL

When in cruise control, the ESCOT ECO-Roll fuel-saving feature calculates when it is optimal for trucks to roll down slope in neutral. It

maintains speed by automatically disengaging the engine when on flat or down slope. This makes use of the truck's momentum instead of burning fuel.



A SMART MOVE FOR FUEL EFFICIENCY

Your fuel-friendly combination.

ESCOT & New Quester GH11E engine – a winning formula for increased fuel efficiency.

Powerful and efficient performance.

The engines deliver high torque and pulling power at low RPMs, while flat torque curve minimizes need for gear changing. Meaning higher average speeds and lower fuel consumption in the long run.

- The GH8E now features 350 hp
- The GH11E has the option of 440 hp

More power and performance when you need it.



GH8E

- 8-liter diesel engine
- Low operating cost via reduced maintenance and long service intervals
- Turbocharging with air-to-air intercooler
- Power/torque: 250 hp/950 Nm, 280 hp/1050 Nm, 330 hp/1200 Nm, 350 hp/1200 Nm

Available transmissions:

- Automatic (Allison)
- Manual

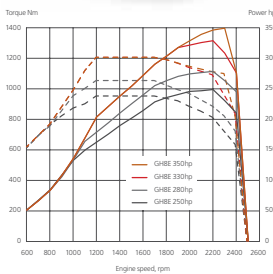

GH11E

- 11-liter diesel engine
- Good torque at low revs delivers fast acceleration
- Low fuel consumption via wide rev range & high thermal efficiency
- Maximum torque within a wide rev range
- Electronically controlled cooling fan reduces losses
- Available with optional UD Extra Engine Brake
- Turbocharging with air-to-air intercooler
- Engine driven power take-off with high torque output of maximum 650 Nm
- Low noise and vibration when idling
- Power/torque: 370 hp/1700 Nm, 390 hp/1800 Nm, 420 hp/2000 Nm, 440 hp/2000 Nm

Available transmissions:

- ESCOT-E automated manual transmission
- Automatic (Allison)
- Manual

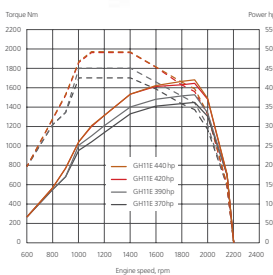

Cruise control

Cruise control reduces driver workload on longer journeys and helps to reduce fuel consumption by maintaining a constant speed.

Electric viscous fan

New Quester features an e-viscous fan, which improves efficiency of the cooling system, increasing engine performance and enhancing engine fuel economy by reducing friction with cooling fan.

UD Telematics services

Our designed solutions are aimed at encouraging better driving behavior and protection of fuel assets:

- Fuel utilization reports provide information about truck and driver performance
- Fuel advisory services encourage better driving behavior
- Fuel loss alert notifies fleet managers about sudden drops in fuel
- With UD Telematics mobile app, optimized fuel performance is at your fingertips

Aerodynamic cab design

New Quester cab is designed for increased fuel efficiency.

- Improved fuel efficiency at highway speeds
- Optional roof deflector reduces coefficient of drag by 5%

The Challenge **DRIVER SHORTAGE.**

Driver shortage has been an issue in the trucking industry for several years. Road freight demands have increased, competition is stronger, and thus the pressure to deliver on time is greater than ever. Attracting and retaining new drivers in these circumstances is a tough task.



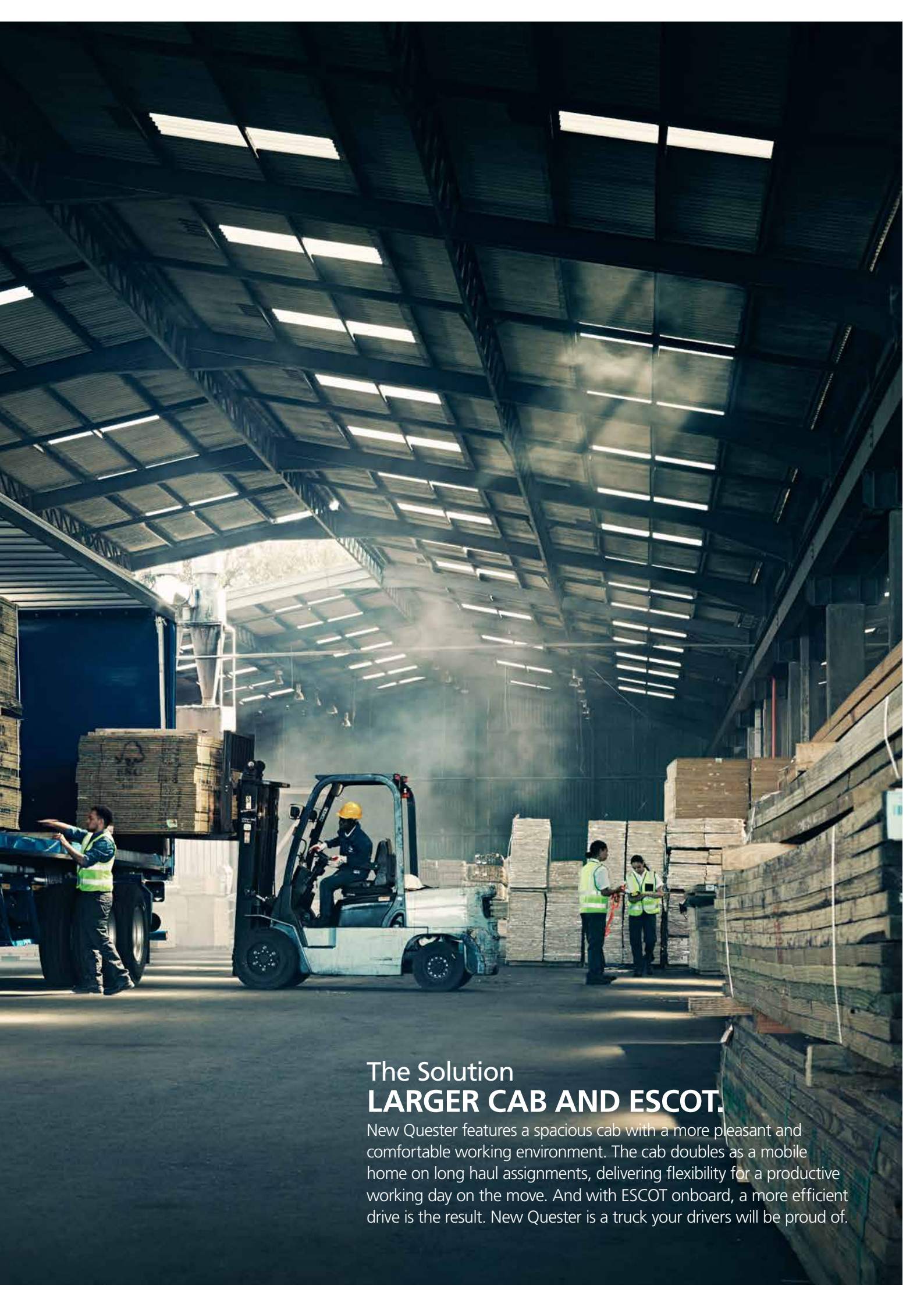

The Solution **LARGER CAB AND ESCOT.**

New Quester features a spacious cab with a more pleasant and comfortable working environment. The cab doubles as a mobile home on long haul assignments, delivering flexibility for a productive working day on the move. And with ESCOT onboard, a more efficient drive is the result. New Quester is a truck your drivers will be proud of.



Interior with Automatic (Allison).

A SMART MOVE FOR DRIVER EFFICIENCY

More space for success.

Giving drivers more comfort and room to live and work opens up your business to more profitable opportunities. New Quester takes this to a new level.

High Roof Cab

The new High Roof Cab is the largest ever built by UD Trucks. An impressively spacious, walk-through cab is equipped with upper and lower bunk beds for shared long-distance assignments.





Cab air suspension

With the introduction of cab air suspension, cab vibration is greatly reduced. This helps lessen driver fatigue and enables better productivity. A smoother ride is also much kinder to the goods being transported. An air suspended cab is more versatile on different types of terrain, and offers a more consistent all-round driving experience.*



New driver seat

Around 80% of truck drivers globally suffer from back problems due to long driving hours. New Quester features a new air suspended seat with lumbar support and optional armrest for improved driver comfort. A worthwhile investment in reducing lost time injuries and retaining drivers.*



A cab to call home

With its easy in and out three-step entrance, New Quester warmly welcomes drivers. All vital instruments are within easy reach, an ergonomically designed dashboard and clear information display allowing focus to stay on the road ahead. There are ample storage options and room for home comforts. All in all, a bright, smart, modern environment that drivers can settle back and get to work in.



New driver training courses

We ensure that all drivers get the full low-down on exactly the truck they will drive. Driver training from day one means that efficient driving and improved fuel economy don't have to wait. Plus, drivers getting familiar with features and daily checks increases on-road safety.

**Available as option on selected models and markets.*

Comfortable and efficient driving performance.

ESCOT, the latest evolution in 12-speed automated manual transmission, and an interior designed for driver comfort, provide a sophisticated and comfortable driving experience that reduces driver stress and fatigue. In an average daily truck operation with a manual transmission, drivers need to shift 1,000 to 1,500 times per day. This constant routine requires focus that could be better devoted to the road and assignment. With ESCOT always selecting the optimal gear, drivers can improve efficiency and productivity regardless of their skill level or experience.

Simple and easy-to-use gear lever

The ESCOT gear lever uses a straight shifting pattern, an evolution in simple and easy-to-use design.

- R Reverse.** Creep function is available in the reverse mode to approach loading dock safely.
- N Neutral.** Gear lever position for when the truck is parked.
- D Drive.** Programmed for automatic and precise gear changes and fuel efficient driving of a professional driver.
- M Manual.** Manual mode. You can use the convenient +/- button on the side of the gear lever to change up and down.



Unparalleled operability

ESCOT provides advanced gear change control and suppresses fluctuations in fuel efficiency. Enhancements to hardware and software control achieve fast and accurate gear changes. Quick and smooth gear changes reduce the driver's level of stress and fatigue while contributing to safe driving. Performance is also improved on uneven surfaces and muddy roads.

The Challenge **NEED FOR GREATER SAFETY.**

With more trucks on the road and drivers far from home base, just one minor accident can throw operations off course and delay important deliveries.





The Solution
SAFER DRIVING.

Safe driving starts with the driver. A number of features including reliable auxiliary braking system and hydraulic retarder make New Quester a wise investment for safer operations.

A SMART MOVE FOR SAFETY

Safety built in for you.

There can be no compromise when it comes to safety. That's why all our built-in safety systems and features are developed and tested to the very highest standards.



High visibility rear view mirrors

New Quester cab provides first-class all-round visibility and depending on customer preference or regulations there are two types of rear view mirrors, namely Japanese type and ECE certified.

Driver training

UD Trucks currently offers several useful courses for drivers. This training helps even experienced drivers improve their efficiency behind the wheel for more cost-effective and safe driving.

ECE certification

The Quester is fully ECE (Economic Commission for Europe) compliant, meaning that cab safety, braking, ADR, lighting and noise requirements are all certified and approved to European standards. ECE R29 for cab strength is part of this certification.

Front Underrun Protection system

The Quester's cab exterior has been designed and developed with the focus on safety. The Front Underrun Protection System (FUPS) is equipped to prevent smaller vehicles from being wedged under the front in the event of a collision.

Available as an option for three-piece steel offroad bumper.

Auxiliary brake

A reliable auxiliary braking system on New Quester helps to maintain safe speeds and delivers powerful braking without fade.

The UD Extra Engine Brake (UD EEB) is a powerful engine brake that is optional with the 11-liter engine. It back pressures the cylinders within the engine, using exhaust pressure and a patented ingenious valve system. There is no generation of heat or extra wear and tear on equipment.

ESCOT and Automatic (Allison)

Cutting out the need for manual gear-changing means drivers can keep their attention on the road. Therefore the addition of ESCOT and option of Automatic (Allison) in New Quester are both good news for operational safety.

Hydraulic retarder

The presence of hydraulic retarder makes downhill driving easier. In loaded vehicles in particular, the vehicle speed can be controlled without applying the service brake. This reduces brake wear and prevents accidents due to brake fade.

Brake Max mode with ESCOT

When not coupled with a hydraulic retarder, ESCOT features a Brake Max Mode which allows the transmission to continuously downshift for a more effective use of the EEB.

Other braking functions include:

- Exhaust brake on GH8E and GH11E enables fast, reliable engine braking
- ABS (Anti-lock Braking System) improves braking on all surfaces
- Full S-cam air brakes are super-durable for constant use



The Challenge **COMPLEX FLEET MANAGEMENT TECHNOLOGY.**

Getting familiar with today's tracking technology isn't easy when fighting against the clock in a daily schedule of demanding assignments. Complex, multi-layered interfaces and login procedures can make it difficult to access the detailed information when you need to make quick, positive decisions to choose the most efficient routes and maximize truck uptime.





The Solution **UD TELEMATICS SERVICES.**

To maximize the profitability of your business, you need to be able to manage your fleet effectively. Keeping it on the road longer while reducing ongoing costs. UD Telematics Services will help you improve your profitability by maximizing vehicle uptime and fuel efficiency, while reducing unplanned stops and operational costs.

A SMART MOVE FOR UPTIME

A longer life for components.

PRODUCT UPTIME

Proven Japanese reliability and robustness are what our trucks offer. Each component is the result of years of development and rigorous stress testing to create the ultimate truck.

New Quester, with its smart, modern, durable features, takes this one step further. For greater peace of mind.

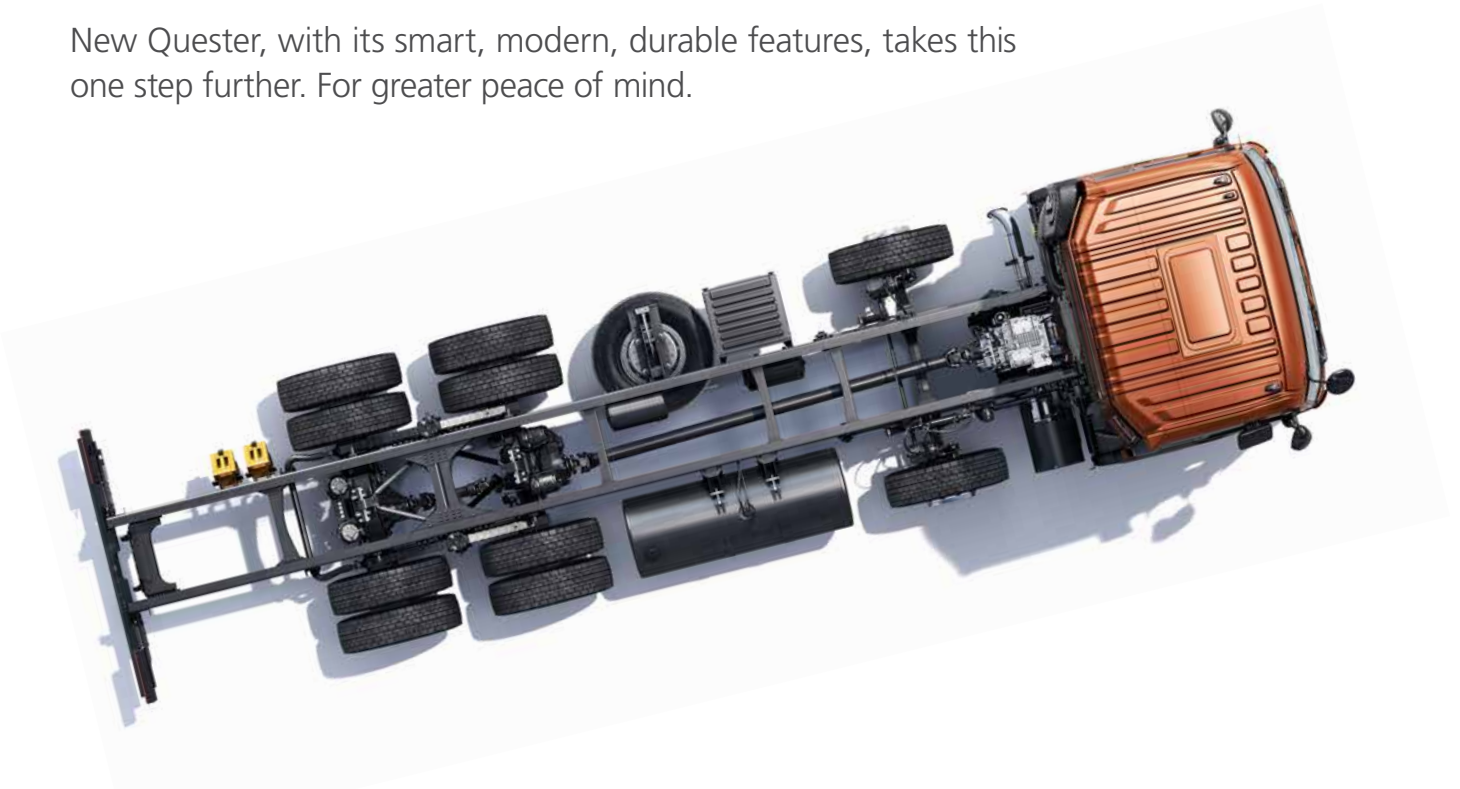

Robust, high-tensile steel chassis frame.

The key to efficient transport is increased payload. Quester uses high-tensile steel rails for the main frame to reduce the vehicle's weight, to achieve further improvements in loading performance.

It also comes with a rolling form frame which is good for vertical stress and torsion stress when rolling and pitching happen together. This reduces stress from uneven road surfaces, loads with high center of gravity and unevenly distributed loads, making it suitable for many different conditions.

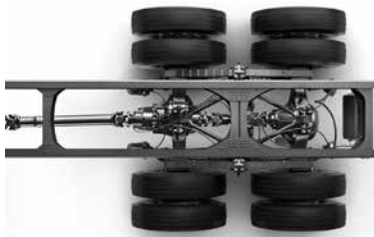

Tough rear leaf suspension

The rear leaf suspension on the 6x4T/R and 8x4R is designed for rough conditions and particularly suitable for construction where durability and high reliability are of highest importance.



Three-piece steel off-road bumper option

A sturdy three-piece steel bumper with high ground clearance and excellent approach angle, is suitable for construction and offroad assignments.



Longer service intervals

The maintenance interval of lubricants for engine transmission and various gears are significantly extended. Oil-bathe type of the front axle hub and the larger capacity of the clutch and brake will reduce the lifetime maintenance costs.



Easy maintenance

The large opening of the electric cab tilt allows for easy, quick and safer access to the engine. For daily inspections and maintenance, a checklist is centralized on the front lid.



Hub reduction for tough jobs

For rough and hilly operations, New Quester offers hub reduction for the 6x4R, 8x4R and 6x4T configurations. The increased robustness of the hub reduction axle ensures easier operation, higher ground clearance and longer life of driveline components.



Extended clutch life span

Clutch life on trucks with ESCOT automated manual transmission is estimated to last much longer than those with manual clutch. A transmission retarder ensures less wear of the service brake liners. This ensures brakes stay healthy and functioning and longer intervals between replacements.



A SMART MOVE FOR **UPTIME**

Your fastest route to profitability.

UPTIME SUPPORT

UD Telematics Services will help you boost your business by maximizing vehicle uptime and fuel efficiency, while reducing unplanned stops and operational costs. Our services integrate a host of features designed to support you and your assignments.

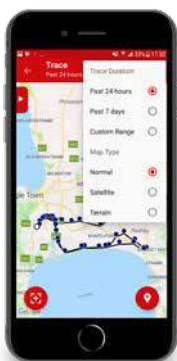

Geofencing allows you to draw virtual boundaries, which alert you with customized messages when your vehicles cross these boundaries. Geofences can also monitor speed limits within each zone and alert you when these speed limit thresholds are crossed.

The UD Telematics mobile app is a compact version of our UD Telematics

web platform, which is available for both iOS and Android devices.

- Know where every truck is, 24/7
- Set the fastest, most direct routes via the Geofencing feature
- Draw boundaries and get alerts if vehicles deviate from route
- Receive alerts when speed limit thresholds are crossed
- Easy-to-understand information

UD Extra Mile Support.



UD Genuine Service

Our UD local Gemba delivers consistent performance for our customers and their businesses. We are continuously improving, being customer-driven, understanding challenges, problems and opportunities. This allows us to go the extra mile to support our customers.

Optimized Service Planning

With longer service intervals, you won't have to visit our workshops and instead get the most out of your fleet. Our optimized service planning uses telematics, which helps us plan any maintenance remotely. It also lets us customize service schedules for your specific application.

UD Service Agreements

Three levels of UD Trust service care are available: UD Trust Standard, UD Trust Extra and UD Trust Ultimate. With these three levels, full transparency, no surprises with unplanned repair expenses and less administration are guaranteed.

UD Driver Training

We want to encourage new drivers to make a positive contribution to your operations. Our Driver Training program is designed to help build driver capability. Courses cover not only vehicle handover and operation, but also the best methods for fuel efficient and safe driving. Dedicated modules are available for long haul drivers.

UD Genuine Parts

Because every part of your trucks matter. Designed and tested to provide the highest quality and durability, and with a one-year warranty, access to UD Genuine Parts increases uptime and lowers costs per kilometer.



UD Telematics

UD Telematics Services is a smart, high-tech wireless communications system supported by our network of UD dealers and specialists. It is designed to improve your competitive position through business improvement and efficiency.

Remote diagnostics monitor truck health and performance, helping to reduce fuel and operational costs, improving fleet management, increasing vehicle uptime and offering you peace of mind.



UD Mobile Workshop

UD mobile workshop brings basic workshop services right to your doorstep. Our trusted professional mechanics can provide preventive maintenance, basic repairs, oil changes or electronic diagnostics using UD Trucks systems and tools. Saving you time and money for the long haul.



UD Road Support

We know how it feels to experience an unexpected standstill. Operating 24/7, UD road support will get you back up and running in no time. Offering reliable UD Genuine Service and quality UD Genuine Parts, our dedicated call center specialists will stay with you every step of the way until your issue is resolved.

"We have made sure that New Quester captures the essential needs in markets around the world today. The truck will keep evolving together with our customers' journey."



“New Quester meets today’s essential needs in our markets around the world.”

Toshi Odawara, Vice President, UD Trucks Quester Product Line talks about Quester’s evolution as a smart and modern transport solution.

Why upgrade the existing Quester to New Quester?

Upgrading the Quester is based on a market need change. The essential needs in growth markets around the world keep changing depending on economic situation and transport industry trends. This means our transport solutions must also adapt and deliver.

What do you believe are the most important challenges that customers face today?

Definitely managing the transport operational cost which in most cases will be managing fuel efficiency. Securing skilled drivers is also becoming crucial to fleet operations.

In what way can New Quester be the solution to these challenges?

New Quester has ESCOT which supports fuel efficient driving, avoiding fluctuation of performance per driver. This will improve overall fuel costs of the fleet. Any driver can perform great. This reduces the pressure on fleet owners to hire good drivers.

How much does the largest cab in UD Trucks’ history contribute to making long haul operations easier?

There are operations in several markets which require two drivers or one driver travelling for more than a week in one trip. It means the drivers will need space to live in the truck – changing clothes,

cooking, sleeping and resting as they do at home. New Quester’s high roof cabin provides sufficient space for drivers to have a more comfortable life on the road.

How do you see New Quester as a part of UD Trucks’ evolving customer partnership?

Since the birth of Quester as a totally new range for UD Trucks, we keep learning from our customers to make sure we provide proper performance and support. And keep improving our products the right way. In Japanese we call this Kaizen. It is the spirit to continue improving things and getting better and better. New Quester is just one step on this road. ■

TECHNICAL SPECIFICATIONS

New Quester range.

Configuration overview

Model	Axle Configuration	Max GVW/GCW (Tons)	Engine Type	Engine Power (hp)	Transmission	Rear Axle
CKE	4x2 Rigid	21T GVW	GH8E	250/280/330	6S MT/ 9S MT	Single reduction
CDE	6x2 Rigid	31T GVW	GH8E	250/280/330	6S MT/ 9S MT/ 6S AT	
CWE	6x4 Rigid	34T GVW	GH8E	280/330/350	9S MT/ 6S AT	Single reduction/ Hub reduction
			GH11E	370/390/420/440	9S MT/ 12S MT/ 12S AMT/ 6S AT	
CQE	8x2 Rigid	38T GVW	GH8E	250/280/330	9S MT	Single reduction
CGE	8x4 Rigid	41T GVW	GH8E	280/330	9S MT	Single reduction/ Hub reduction
			GH11E	370/390/420/440	9S MT/ 12S MT/ 12S AMT/ 6S AT	
GKE	4x2 Tractor	48T GCW	GH8E	280/330	9S MT	Single reduction
			GH11E	370/390/420/440	9S MT/ 12S MT/ 12S AMT	Single/ Hub reduction
GDE	6x2 Tractor	56T GCW	GH8E	280/330/350	9S MT	Single reduction
			GH11E	370/390/420/440	9S MT/ 12S MT/ 12S AMT	
GWE	6x4 Tractor	80T GCW	GH8E	280/330/350	9S MT	Single reduction/ Hub reduction
			GH11E	370/390/420/440	9S MT/ 12S MT/ 12S AMT	

High roof cab on all New Quester models | All emissions are available in EU3 and EU4 except the 11L 440hp, 8L 220 and 8L 350hp.

Wheelbases

Tractor	3200			3400			3500			3600			3700		
4x2								○							○
6x2					○										
6x4		○			○							○			

Rigid	3400	3500	3700	3900	4000	4100	4300	4600	4900	5100	5200	5600	5800	6000	6100	6300	6500
4x2		○			○		○	○	○		○			○			○
6x2								○		○		○			○		○
6x4		○		○	○		○	○	○		○	○			○		
8x2												○	○				
8x4							○	○	○	○		○				○	

Load capacity

Tractor	REAR SUSPENSION		FRONT SUSPENSION		DRIVELINE	
	Type	RAL	Type	FAL	Engine	Rear axle
GKE 4x2T	Multileaf	13t	Parabolic	7.5/8.0t	GH11E/GH8E	Single Reduction
GKE 6x2T	Multileaf	23t	Parabolic	7.5/8.0t	GH11E/GH8E	Single Reduction
GKE 6x4T	Multileaf	23/26t	Parabolic	7.5/8.0t	GH11E/GH8E	Single/Hub Reduction

Rigid	REAR SUSPENSION		FRONT SUSPENSION		DRIVELINE	
	Type	RAL	Type	FAL	Engine	Rear axle
CKE 4x2R	Multileaf	13t	Parabolic	7.5/8.0t	GH8E	Single Reduction
CDE 6x2R	Multileaf	23t	Parabolic	7.5/8.0t	GH8E	Single Reduction
CWE 6x4R	Multileaf	23/26t	Parabolic	7.5/8.0t	GH11E/GH8E	Single/Hub Reduction
CGE 8x4R	Multileaf	23/26t	Parabolic	15t	GH11E/GH8E	Single/Hub Reduction
CQE 8x2R	Multileaf	23t	Parabolic	15t	GH8E	Single Reduction

Chassis

The chassis is designed to provide very high vehicle strength and reliability. Large offer of chassis layouts to give a flexible packing arrangement including different wheelbases, range of fuel tank sizes and different exhaust directions. Large range of options to meet legal requirements on some markets such as side and rear under-run protection, propeller shaft catcher, rear reflectors. Range of optional extras such as wheel chocks, spare wheel carrier, towing member and couplings.

Maintenance

Engine Service points are located behind the grille for ease of service. The oil dipstick is conveniently located at the back of the cab. Cab tilt angle 58 degrees for ease of access to the engine.

Frame

Roll formed high-tensile steel frame providing strength, elasticity and excellent durability thanks to high resistance against both vertical loads and torsional stress. Frame in either 7 or 8 mm thickness with strength 590 N/mm². Different length of 5 mm inner liner available as options for additional strength.

Fuel tanks

Round shaped steel fuel tanks mounted either LHS or RHS. Low profile 560 mm in size 210 or 315 liters. High profile 710 mm in sizes 210, 315, 405 or 610 liters. Fuel cap lock offered as option. D shaped aluminum tanks also available as an option. 710mm dia in sizes of 405L or 330L, or a combination of 490+330L for 6x4T model only.

Bumper

Two options available:

- Three piece moulded composite bumper designed for on-road use. Aerodynamic design and low ride height contributes to better fuel economy. Front under-run protection as standard. Fog lamps available as an option.
- Sturdy three piece steel bumper designed for construction and off-road applications. High ride height contributes to high ground clearance and good approach angle.

Rear wings and mudguards

Made of durable plastic as standard on tractors. Rear quarter wings are available as an option. Fenders are an option on rigid vehicles.

Fully built tractors

4x2/6x2/6x4 fully built tractors directly from the factory. SAF-Holland or JOST low maintenance fifth wheel options. Different fifth wheel positions can be ordered. High trailer connection arch for convenient trailer coupling. Reduces risk of damage to cables and air hoses. Catwalk with anti-slip surface as an option. Steel footstep on the battery box. Trailer brake connections. Working lamp as standard

ADR

ECE tested ADR specification is available as an option for Quester models specified with manual transmissions. This provides a fully protected wiring harness and electrical system shut-off switch on the dashboard.



Suspension

Front suspension

Front parabolic springs provide high strength combined with low weight. Front axle load is either 7.5 tons or 8 tons. On the 8x4R the front axle load is 15 tons.

Rear suspension 6x4T/R and 8x4R

Can be specified with a 23T capacity multileaf bogie for light load applications, or a 26T multileaf bogie for heavy duty applications. Load distribution is always 50/50. Designed for rough conditions and particularly suitable for construction. Rubber springs between the springs and rear axles contribute to good comfort under all axle loads. Rubber journalled V-stays and reduction rods take up both longitudinal and transverse forces to give a smooth operation. Available for high chassis height with both single and hub reduction axles. Stabilizer as option for construction applications.

Rear suspension 6x2T/R and 8x2R

This is specified with the rear suspension with a maximum bogie load of 23 tons. Multileaf spring with 9 leaves for rigid and 8 leaves for tractors. Load distribution 50/50. Available with different options depending upon the market requirements:

- Bogie lift (BOGLIFT)
- Bogie press (BOGPRESS)
- Without lift (ULIFT)

Rubber springs between the springs and rear axles contribute to good comfort under all axle loads. Rubber journalled V-stays and reduction rods take up both longitudinal and transverse forces to give a smooth operation. Available for chassis height medium with single reduction axles.

Rear suspension 4x2T/R

This is specified with the rear suspension with a maximum axle load of 13 tons.

Sixteen (16) leaf dual stage multileaf spring. Designed for high strength with good comfort. The main spring works when the vehicle is partially loaded and the helper spring comes into action at full load. Available for chassis height medium with single reduction axles. Spring length 1 370 mm, width 90 mm. Sliding type attachment.

Brakes

Brake system

Pneumatically controlled. Full air brake system with S-cam drum brakes. Automatic slack adjuster. ABS (Anti-lock Braking System) is available as option. Auxiliary parking brake chamber as option intended for heavier gross combination weights to fulfill the requirements of added parking brake power in this segment.

Auxiliary brakes

Exhaust engine brake. The GH11E engine can be specified with the optional UD Extra Engine Brake (UD EEB). An integrated hydraulic retarder is available as an option with ESCOT-E and Automatic (Allison) transmissions, for more effective braking and longer life of service brakes. When specified, the retarder actuation is integrated into that of the exhaust/engine brake stalk.



Driveline

Engine GH11E | Power/Torque

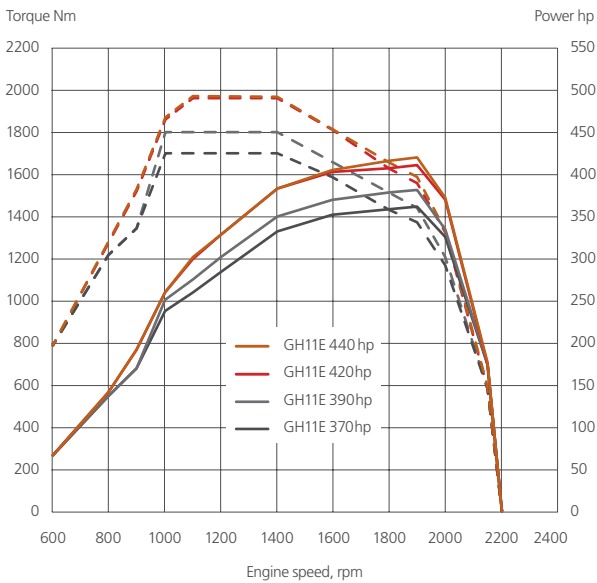

GH11E general description

In-line 6-cylinder four-stroke diesel engine with unit injector high-pressure direct injection. 4 valves per cylinder. Turbocharging with air-to-air intercooler.

Displacement	10.8 liters
Bore	123 mm
Stroke	152 mm
Compression ratio	18.3:1
Exhaust brake effect at 2400 r/min	218 hp (160 kW)
UD Extra Engine Brake (UD EEB) at 2400 r/min	395 hp (290 kW)
Economy rev range	900–1400r /min
Optimum rev range	1100–1300r /min
Oil-change volume, including oil filters	approx. 33 liters
Oil filters, no.	2 full-flow, 1 bypass
Cooling system, total volume	approx. 36 liters
Dry weight (base engine)	approx. 983 kg
Emission level	EU3 and EU4

GH11E 370hp

Max Power at 1900 r/min	370 hp (273 kW)
Max Torque at 1000–1400 r/min	1700 Nm

GH11E 390hp

Max Power at 1900 r/min	390 hp (287 kW)
Max Torque at 1000–1400 r/min	1800 Nm

GH11E 420hp

Max Power at 1900 r/min	390 hp (287 kW)
Max Torque at 1000–1400 r/min	1800 Nm

GH11E 440hp (EU3 only)

Max Power at 1900 r/min	440 hp (324 kW)
Max Torque at 1100–1400 r/min	2000 Nm

Engine GH8E | Power/Torque

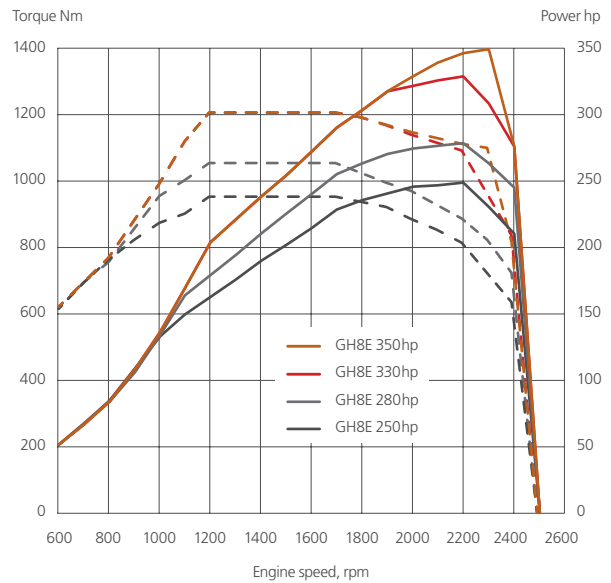

GH8E general description

In-line 6-cylinder four-stroke diesel engine with common rail high-pressure direct injection. 4 valves per cylinder. Turbocharging with air-to-air intercooler.

Displacement	7.7 liters
Bore	110 mm
Stroke	135 mm
Compression ratio	17.5:1
Exhaust brake effect at 2500 r/min	145 hp (107 kW)
Economy rev range	900–1600r /min
Oil-change volume, including oil filters	approx. 20 liters
Oil filters, no.	1 full-flow
Cooling system, total volume	approx. 37 liters
Dry weight (base engine)	approx. 712 kg

GH8E 250hp

Max Power at 2200 r/min	250 hp (184 kW)
Max Torque at 1000–1700 r/min	950 Nm

GH8E 280hp

Max Power at 2200 r/min	280 hp (206 kW)
Max Torque at 1000–1700 r/min	1050 Nm

GH8E 330hp

Max Power at 2200 r/min	330 hp (243 kW)
Max Torque at 1200–1650 r/min	1200 Nm

GH8E350hp

Max Power at 2250 r/min	350 hp (258 kW)
Max Torque at 1200–1650 r/min	1200 Nm

Transmission

Manual Transmission

Type	Top gear	Input torque	Gears	8L	11L
ST1006	Directdrive	1000 Nm	6 (220/250 hp)	○	
ST1306	Directdrive	1300 Nm	6 (280 hp)	○	
ST1199	Directdrive	1190 Nm	9 (250/280 hp)	○	
STO2009	Overdrive	2000 Nm	9 (370/390/420 hp)		○
STO2012	Overdrive	2000 Nm	12 (370/390/420 hp)		○

Automated Manual Transmission (AMT)

Type	Top gear	Input torque	Gears	11L
ESCOT-E	Overdrive	2600 Nm	12 (370/390/420/440 hp)	○
	Directdrive	2600 Nm	12 (370/390/420/440 hp)	○

Automatic (Allison) 6-speed fully automatic transmissions

Type	8L	11L
AL306	○	
AL326	○	
AL446		○

Clutch

Hydraulically operated single-disc clutch.

Transmission ratio Manual

GH8E: 8.71–1.00 (6-speed); 12.11–1.00 (9-speed)
 GH11E: 13.95–0.73 (9-speed); 12.10–0.78 (12-speed)

Transmission ratio AMT

GH11E: 11.729–0.785 (12-speed OD); 14.941–1.00 (12-speed DD)

Rear axle ratios

A wide range of ratios is available, so that the driveline can be optimized in order to get the maximum drivability and best fuel economy in the required application.

Single reduction axle	Max. engine torque	Reduction
Hypoid gear	2000 Nm	Tandem: 3.70, 4.11, 4.30, 4.63, 5.14, 5.57, 6.17 Solo: 3.91, 4.30, 4.89, 5.63

The tandem single reduction axle is equipped with a reliable and robustly dimensioned inter axle differential lock.

Hub reduction axle	Max. engine torque	Reduction
Spiral gear + Planetary gear	2000 Nm	4.87, 5.24, 5.79, 6.37

The tandem hub reduction axle is equipped with reliable and robustly dimensioned 2 stage differential lock as standard. Stage 1 is inter-axle and stage 2 is between axles.

Power Take-Off (PTO) system

Engine PTO options are available on both 8L and 11L engines with either a flange or a spline output. Various transmission PTO options are also available with both output types on the manual and AMT transmissions.

Cabin

Exterior

- Standard roof cab with option of on-road or steel off-road bumper
 - High roof cab with on-road bumper or steel off-road bumper
- Modern styling with robust look on the construction truck:
- Front under-run protection as standard on the on-road bumper and optional for steel off-road bumper
 - Low running costs due to aerodynamic design and option of air deflectors
 - Coil spring suspension or air suspension as an option for high comfort, durability and easy maintenance
 - Electric cab tilting for convenience and easy servicing access
 - Step height on tractor chassis 510 mm, bar type steel step

Interior dimensions	Standard roof	High roof
Length, (front window to back panel)	1830 mm	2030 mm
Width, (inner door trim to door trim)	2090 mm	2090 mm
Height, (floor to roof above driver's head)	1445 mm	2000 mm

Dashboard

Ergonomically designed to ensure that the most important controls and switches are within easy reach of the driver and also that the switches are marked. They are easily recognizable. The steering column has easily adjustable angular and telescopic adjustment to give the driver the best driving position.

Driver's information display

With a large, easy-to-read 4.5-inch screen integrated in the instrument cluster. Providing a wide range of vehicle, diagnostic and trip information, as well as fuel coaching and data logging.

Fuel coaching system

A real-time driving guidance tool displaying actions required to achieve optimized fuel economy operation with manual transmissions.

Cruise Control

Cruise control reduces driver workload on longer journeys and helps to reduce fuel consumption by maintaining a constant speed.

Seats

Two variants of interior layout, 3-seater or 2-seater. High-quality textile upholstery. Ergonomically designed driver's seat with integrated headrest. Air suspended seat with lumbar support and armrest with height adjustment of 80 mm and fore-aft adjustment of 190 mm.

Climate system

- Three variants available:
- Air conditioning and heater
 - Air conditioning only
 - Ventilation unit only

Audio system

With AM/FM radio and USB port for MP3 player.

Bunks

Double bunk for high roof. Single bunk for standard.

Storage compartments

Under bunk space 151 liters (High roof), 104 liters (Standard roof). Head shelf 90 liters (High roof), 20 liters (Standard roof).

Roof hatch

For increased safety in high roof cab.

Rear window

Fixed glass as standard.

Specifications and options may differ depending on each country due to regulations or special requirements. Please contact your nearest UD Trucks dealer for further details.



UD TRUCKS

All images in this brochure are specially created with computer graphics for brochure use: They may vary in comparison to the specifications or colors of actual vehicle models. When an option is attached, a vehicle weight may change. For details on each vehicle, please contact your local UD Trucks dealer. The specifications and other information in this brochure are subject to change without prior notice. (This brochure is current as of January 2019).

UD Trucks manufactures standard vehicle which does not include technical modification on the truck chassis to comply with the rules imposed by international conventions, relevant national legislation, and transport standards for specific purposes such as hazardous substance transport. Any such modification needs to be done by bodybuilder or customer, and in no event shall UD Trucks be liable for any liability, loss, injury or risk which is incurred or suffered as a result of such use of the vehicle.

UD Trucks Corporation
1-1, Ageo-shi, Saitama 362-8523, Japan
udtrucks.com